

## FOREWORD

This section must be read before any connection is made to the mains supply.

### WARNINGS

- Do not expose the equipment to rain or moisture.
- Do not remove the cover from the equipment.
- Do not push anything inside the equipment through the ventilation holes.

### COPYRIGHT

Recording and playback of any material may require consent. For further information refer to the following:

- Copyright Act 1956
- Dramatic and Musical Performers Act 1958
- Performers Protection Acts 1963 and 1972
- any subsequent statutory enactments and orders

## INTRODUCTION

Please read these operating instructions carefully. We recommend that you read the entire user guide before you connect or operate the unit.

After you have reviewed the contents this manual, we suggest that you make all system connections before you attempt to operate the unit.

## PRECAUTIONS

The following precautions should be considered when operating the equipment.

When setting the equipment ensure that :

- air is allowed to circulate freely around the equipment
- the equipment is on a vibration free surface
- the equipment will not be exposed to interference from an external source
- the equipment will not be exposed to excessive heat, cold, moisture or dust
- the equipment will not be exposed to direct sunlight
- the equipment will not be exposed to electrostatic discharges
- In addition, never place heavy objects on the equipment.
- If a foreign body or water does enter the equipment, contact your nearest dealer or service center.

## Features

- A full compliment of input and output jacks:
  - XLR stereo input jacks for microphone or line level signals.
  - Line level RCA output jacks.
  - Digital coaxial (RCA) input jack.
  - Digital XLR output jack (with ON/OFF switch).
- Professional microphone specifications:
  - Phantom power (+48V).
  - Microphone attenuation adjustment.
  - ANC (Ambient Noise Control) switch for eliminating unwanted background noise.
- Professional system specifications ensure safe recording:
  - Automatic UTOC (User Table Of Contents) updates whenever STOP (■) is pressed.
  - Large (16MB) shock proof memory buffer can hold up to 20 seconds of stereo (40 seconds of mono) sound during playback or recording.
  - On board backup of UTOC data, preset modes, and date and time.
- Fully adjustable recording features:
  - Three record level options: manual, manual with limiter, and automatic (ALC).
  - LSR (Level Sync Recording) allows you to start recording automatically when the input signal reaches a preset level.
  - Adjustable PRE REC memory cache that monitors the input signal (during rec-pause) to completely eliminate lag time at start of recording.
  - Various recording formats: two channel (stereo), dual level mono, mixed mono, and mono.
  - One touch recording with auto end search.
  - Date and time information stored automatically with each track.
- Edit functions allow you to divide, combine, move, and delete a track, delete a whole disc. You can also title the disc and the individual tracks.
- Internal sampling rate converter that lets you make digital recordings from a wide variety of program sources; 32 kHz, 44.1 kHz (CD, MD, etc.) and 48 kHz (DAT, etc.).
- 3-way power supply.
- Power management control:
  - Power turns off automatically after 5 minutes of non-operation (alarm sounds 30 seconds before power off).
  - Internal battery charger for (optional) NiCd pack.
- Built in (12 or 24 hour) clock automatically imprints the date and time of recording on each track.
- Two recording modes; SP (Standard Play, stereo) and LP (Long Play, mono).
- Built-in mono condenser microphone.
- Built-in speaker.
- Backlit LCD display.
- Remote jack for optional wired remote control (RC-5).

# How to Use this Manual

This manual is divided into the five sections described below. To find out how to use a specific control, refer to the "Index of Parts and Controls" on page 100.

## SETTING UP

This section provides information about; compatible power supplies, system presets, the internal clock, MiniDiscs, and how to connect various devices (such as microphones, audio components, a remote control, and headphones).

## RECORDING

The first four parts of this section explain the settings necessary for each method of recording (built-in microphone, external microphones, analog, digital). The final section "Recording Operations" explains the recording modes (SP and LP), how to set the recording level, and shows you the actual recording operations (etc.).

## PLAYBACK

This section describes the various playback operations, including how to skip and search. "Repeat Play" shows you how to repeat a track, the entire disc, or a part of a track.

## EDITING

This section describes the various editing operations: divide, combine, move, erase, and title.

## ADDITIONAL INFORMATION

This section includes detailed information about the MD recording system, SCMS (Serial Copy Management System), troubleshooting, and explanations of various error messages that may appear in the display. The final section, "Index of Parts and Controls", allows you look up operations of specific controls.

# Contents

## SETTING UP

Power Supplies .....	6
Adjusting the System Presets .....	7
Setting the Date and Time .....	8
Connecting Microphones .....	10
Connecting Analog Components .....	10
Connecting Digital Components .....	11
Other Connections .....	11

## RECORDING

Recording with the Built-in Microphone .....	12
Recording with External Microphones .....	12
Recording Line Sources .....	13
Recording Digital Sources .....	13
Recording Operation .....	14

## PLAYBACK

Basic Operation .....	16
Repeat Play .....	17

## EDITING

Dividing a Track .....	19
Combining Tracks .....	19
Moving a Track .....	20
Erasing a Disc or Track .....	20
Titling a Disc or Track .....	21

## ADDITIONAL INFORMATION

System Limitations .....	22
SCMS Copy Protection .....	23
Troubleshooting .....	25
Display Messages .....	26
Specifications .....	26
Index of Parts and Controls .....	100

## Power supplies

### AC Adaptor

When recording for extended periods, or using this unit in a studio environment, we recommend using the AC adaptor.

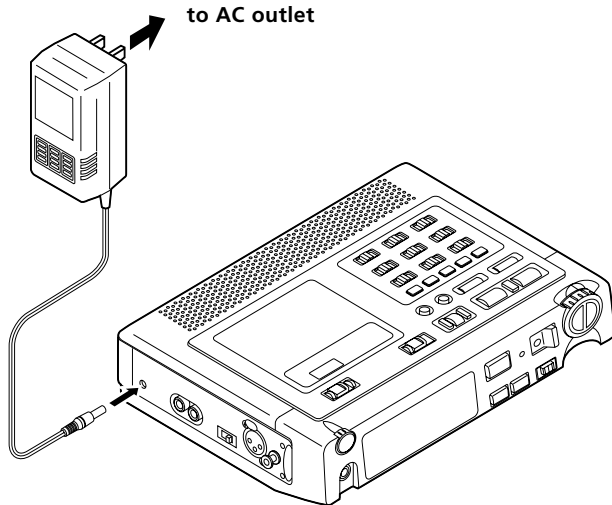

#### Notes

- If the voltage of the power supply exceeds the specified value, "HIGH DC IN" blinks in the display for 3 seconds, and the unit turns off.
- This adaptor is also used to recharge the (optional) NiCd battery pack. See "Rechargeable NiCd Battery Pack (optional)" for details.

### Alkaline Batteries

The PMD650 takes 8 standard AA-type alkaline batteries. Refer to the following illustration to load the batteries.

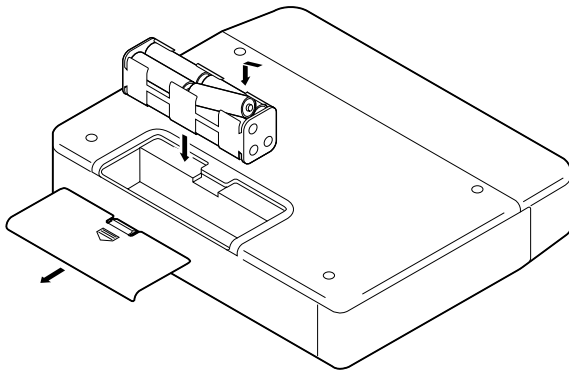

#### Notes

- Use only AA batteries for replacement.
- Be sure to insert the batteries with correct polarity (as illustrated on the battery compartment).
- Remove the batteries if the unit will not be used for an extended period of time.
- If batteries leak, dispose of them immediately. Avoid touching the leaking material or letting it come into contact with clothing, etc. Clean the battery compartment thoroughly before installing new batteries.
- Do not use new batteries together with batteries that have been previously used.
- It is possible to insert (AA-type) NiCd batteries into the battery holder, but they cannot be recharged.

### Rechargeable NiCd Battery Pack (optional)

The PMD650 can also use an optional NiCd rechargeable battery pack (RB1100). Be sure the battery pack is fully charged before use. Refer to the following illustration to install the battery pack.

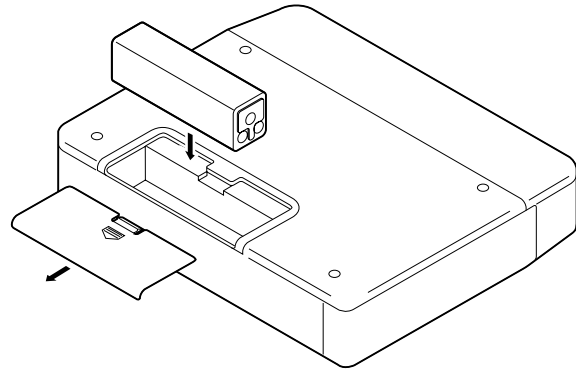

#### To charge the battery pack

- ① Make sure the NiCd battery pack is loaded into the PMD650 (as shown above).
- ② Connect the PMD650 to a wall outlet using the AC Adaptor (see "AC Adaptor").
- ③ Set the PMD650 to off (standby).  
The CHARGE indicator located next to the DC IN 13V jack blinks while the pack is charging and lights steadily when it is fully charged. A full charge takes approximately 3 hours.

#### Note

- The CHARGE indicator will not light if the power is on. In this case, the PMD650 operates using the AC power from the wall outlet.
- Due to the characteristics of the NiCd battery, its useable battery time when charged may be substantially decreased during the course of repeated charging and discharging of the battery. In this case unplug the AC adaptor and, without removing the NiCd battery, leave as is for 2 to 3 days. After this period, recharge the battery again.

- It is recommended that this NiCd battery is used within a temperature range of between 10 degrees Celsius and 30 degrees Celsius in order to attain the best performance.
- Do not short-circuit the terminals. Do not place the NiCd battery in pockets or handbags together with necklaces or other metallic objects.
- Never immerse the NiCd battery in water, subject it to naked flames or attempt to dismantle it.

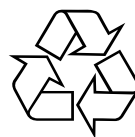

## Power Management

The PMD650 is equipped with a sliding POWER switch that toggles the unit between on and off (standby). It also incorporates a power management function that turns the power off automatically after 5 minutes of non-operation when using battery power. The unit will beep 30 seconds before the power is automatically turned off. You can turn off the power management alarm, if necessary, by setting the ALARM preset to OFF as described in the following section “Adjusting the System Presets”.

### To turn the unit on

Slide POWER to the right.

### To turn the unit off (standby)

Slide POWER to the right. If turned off during recording, the unit always writes the UTOC before turning off.

## Battery replacement

The battery icon in the display shows battery strength in three steps:

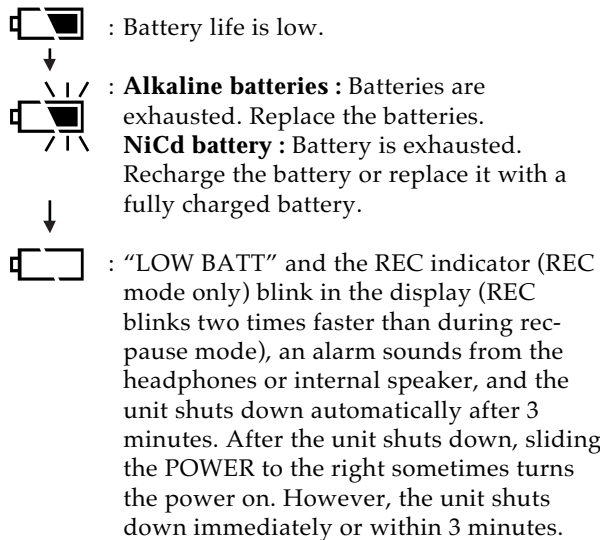

### Notes

- If the battery failure occurs during recording, the UTOC is updated before shutting down.
- During recording, the alarm sounds from the headphones only.
- The alarm can be turned off. See “Adjusting the System Presets” for details.

## Battery life

Battery type	Recording	Playback
Alkaline batteries	about 3.5 hours	about 4.0 hours
Optional NiCd battery	about 2.5 hours	about 3.0 hours

### Notes

- When recording, to avoid loss of battery power, it is recommended to always use new alkaline batteries, or a fully charged battery pack.
- Battery life may vary depending on the conditions under which the unit is operated (environmental temperature, humidity, speaker usage, DIGITAL OUT ON/OFF, etc.).
- This unit will maintain a backup of date and time for approximately one month, even with the batteries removed.

## Adjusting the System Presets

The system presets described below can be adjusted according to your needs and preferences.

- **Power management alarm (ALARM)**  
This preset determines whether or not the beep alarm will sound before the unit’s power is automatically turned off. The alarm beeps 30 seconds before the power management function turns the power off. Likewise, it also beeps 5 minutes before battery failure (“LOW BATT”).
- **LSR level (LSR\_L)**  
This preset determines the minimum signal level necessary to trigger the LSR (Level Sync Recording) function. (See “LSR” on page 14 for details.)
- **New track time (NTT) (in LSR mode)**  
Tracks are marked in sync with the input level of the source signal. This preset determines how long a low level (LSR level) signal must continue before the unit marks a new track (see “LSR” on page 14).  
For example: If NTT is set to 3 seconds, when the source signal falls below LSR level for 3 seconds or more, a new track is marked the next time the source signal rises above the LSR level (with the LSR set to ON and the TR\_INC set to On).
- **Track increment (TR\_INC) (in LSR mode)**  
This preset determines whether or not new track numbers will be automatically assigned to new tracks. See “LSR”.
- **Pre recording time (PR\_REC)**  
When the unit is set to rec-pause mode, it can monitor the source signal and maintain a memory cache which eliminates any time lag in the recording operation (and can even allow you to start recording slightly beforehand). This preset determines the length of the memory cache.
- **Time system (Time)**  
This preset lets you choose either a 12 hour (AM/PM) or 24 hour (military) time system.
- **Date form (DATE)**  
This preset lets you choose the order of the date (day, month, year) information.
- **Battery type (BATT)**  
For the most accurate indication of the battery life, set this preset to the type of battery you are using.

Continued on next page

- Sampling rate converter (SRC)  
This preset lets you use this unit as a Sampling Rate Converter (SRC).  
When set to On, digital signals input to the DIGITAL IN jack are routed through the SRC, converted, and then simultaneously output from the DIGITAL OUT jack and recorded to the MD.  
When set to Off, digital signals input to the DIGITAL IN jack are output from the DIGITAL OUT jack as is. If the input signals are 32 kHz or 48 kHz, they are converted by the SRC before being recorded to the MD. If the input signals are 44.1 kHz, they are recorded directly to the MD without going through the SRC.
- SCMS copy protection (SCMS)  
This preset lets you turn the SCMS on or off.

Preset (display)	Adjustable range*
Alarm (ALARM)	On, Off
LSR level (LSR_L)	-60, <b>-40</b> , -20, -10 (dB)
New track time (NTT)	02, <b>03</b> , 05, 10 (sec.)
Track increment (TR_INC)	On, Off
Pre-rec time (PR_REC)	0, <b>0.5</b> , 1.0, 2.0 (sec.)
Time (TIME)	12h, <b>24h</b> (hour)
Date form (DATE)	<b>D.M.Y.</b> , M.D.Y, Y.M.D
Battery (BATT)	<b>Alk</b> , NiCd
SRC (SRC)	On, <b>Off</b>
SCMS (SCMS)	<b>On</b> , Off

\* Default values in **bold**.

## To change a preset

- 1 Press STOP (■).
- 2 Press EDIT < or > repeatedly until "Preset?" is displayed, then press ENTER.  
The first preset "ALARM" appears in the display.

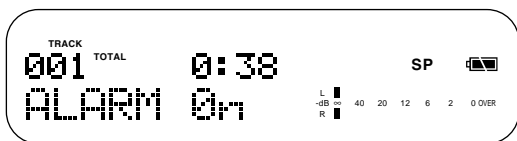

- 3 Press PLAY/PAUSE (▶/||) repeatedly to select the preset you want to change.
- 4 Press FR/PREV (◀◀/|◀◀) or FF/NEXT (▶▶/▶▶) to change the preset.
- 5 Press ENTER to enter the changes.  
"Complete!" appears and the unit returns to normal operation.

## To cancel preset adjustment

- Press STOP (■) during steps ② through ④.
- Opening or closing the disc holder also cancels the preset adjustments.

## Setting the Date and Time

Before operating the PMD650, perform the following operations to set the current date and time. The current date and time are recorded automatically at the beginning of each track.

### Ex.: When the date form is in type D.M.Y.

- 1 Slide POWER to the right to turn on the unit.
- 2 Press EDIT < or > repeatedly until "Clock Adj?" is displayed, then press ENTER.

The unit enters the date/time setup mode and the day indication starts blinking.

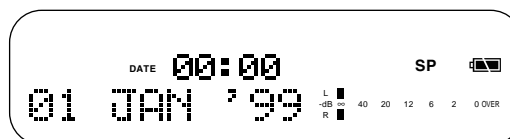

When the time mode is set to "24h", the AM/PM indicator does not light and step ⑥ below is not necessary. (See "Adjusting the System Presets" on page 7 to set the time mode.)

- 3 Press FR/PREV (◀◀/|◀◀) or FF/NEXT (▶▶/▶▶) to set the day, then press PLAY/PAUSE (▶/||) to enter it.  
Keep pressing FR/PREV or FF/NEXT to increase or decrease the number continuously.
- 4 Press FR/PREV or FF/NEXT to set the month, then press PLAY/PAUSE to enter it.
- 5 Press FR/PREV or FF/NEXT to set the year, then press PLAY/PAUSE to enter it.
- 6 Press FR/PREV or FF/NEXT to select AM or PM, then press PLAY/PAUSE to enter it.
- 7 Press FR/PREV or FF/NEXT to set the hour, then press PLAY/PAUSE to enter it.
- 8 Press FR/PREV or FF/NEXT to set the minute, then press ENTER to enter it.  
"Complete!" appears, the seconds will start counting and the unit will automatically return to its normal operation mode. Alternatively, you can press PLAY/PAUSE (▶/||) to return to step ③.

### To exit without setting all fields

Press ENTER during steps ③ through ⑦. The fields you set are stored, "Complete!" appears, and the unit returns to its normal operation mode.

### To cancel clock adjustment

Press EDIT < or > or STOP (■).

## Viewing the date and time

Each time you press DISPLAY, the display switches as shown below according to the state of operation.

The display remains in the selected mode until the disc is ejected. The first display (①) is the default displays for the respective mode.

### During stop mode

- ① Disc information

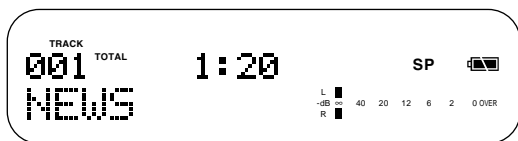

- ② Time available for recording (Recordable disc)

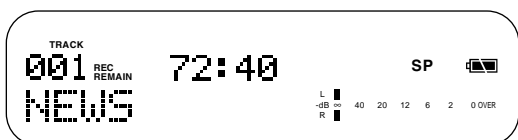

#### Note

In case of pre-mastered disc, 0:00 is displayed.

- ③ Current date and time

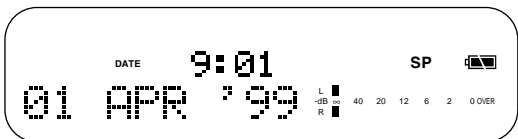

### During recording

- ① Time elapsed during recording

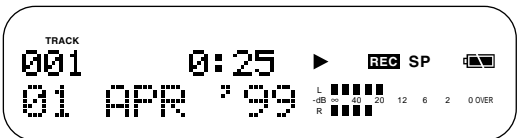

- ② Time available for recording

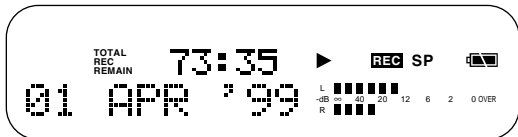

- ③ Current date and time

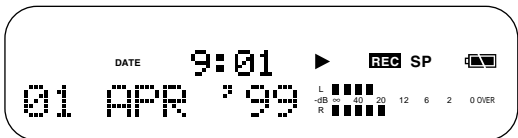

#### Note

When the title is input, the title is displayed in ① and ②. When the title is not input, the date will be displayed instead of "No Name".

"hh:mm\_(dd)" in 24 hour display mode.

"hh:mmA(dd)" in 12 hour display mode in AM.

"hh:mmP(dd)" in 12 hour display mode in PM.

### During playback

- ① Time elapsed on current track

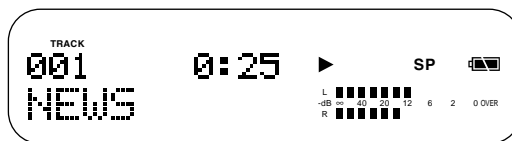

- ② Time remaining on current track

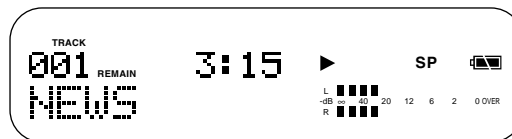

- ③ Time remaining on the disc.

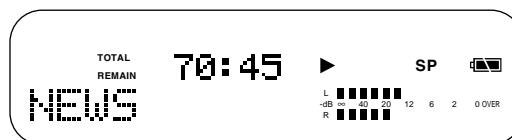

- ④ Date and time of recording

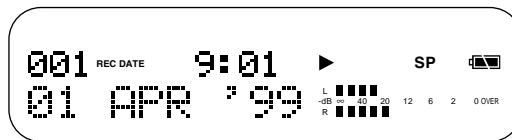

#### Note

The remain time is displayed in SP mode.

### To illuminate the display

For temporary illumination, press LIGHT. The backlight comes on for 3 seconds and turns off automatically. When the LIGHT is pressed again with the backlight on, the backlight is turned off.

For longer illumination, hold down LIGHT for more than 1 second. The backlight will stay on until the next time you press LIGHT.

## Connecting Microphones

Connect the microphones as shown below.

You can connect two microphones for stereo to the MIC/LINE IN L and R (XLR) jacks.

Alternatively, you can connect just one microphone (for mono recording or dual level mono recording) to the MIC/LINE IN L jack.

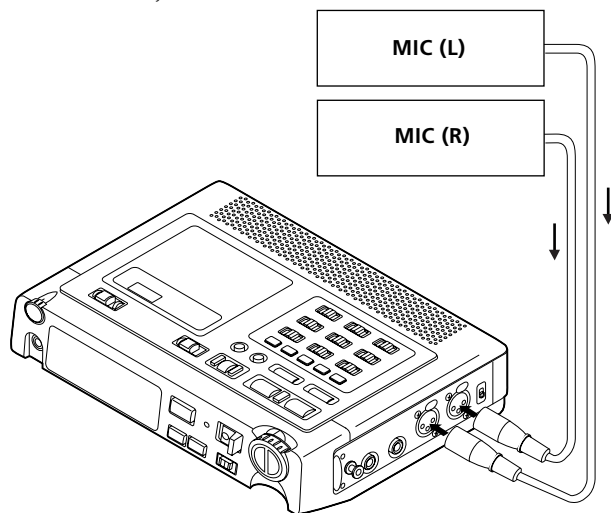

### Powering the microphone(s)

This unit can also supply +48 V of phantom power to the connected microphone(s). If your microphone(s) require phantom power, set PHANTOM +48V to ON.

### Notes

- Phantom power is only applicable to condenser microphones. See the instruction manual of your microphones if phantom power is required.
- Do not use phantom power in combination with dynamic microphones to avoid damage to the unit or the microphones.
- You can also compensate for different microphones and/or environments. (See "ANC" and "MIC ATTENUATION" on page 12 for details.)

## Connecting Analog Components

The following illustrations show you how to connect analog audio components for recording or playback.

### To record from analog audio components

Connect the source component's analog line output jacks to this unit's MIC/LINE IN L and R (XLR) jacks.

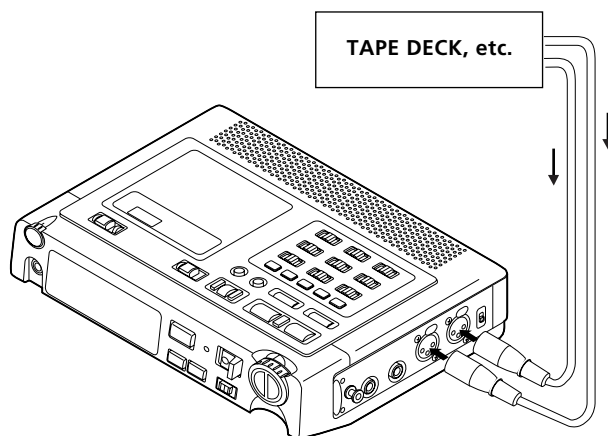

### To output analog audio signals to another audio component

Connect the source component's analog line input jacks to this unit's LINE OUT L and R (RCA) jacks.

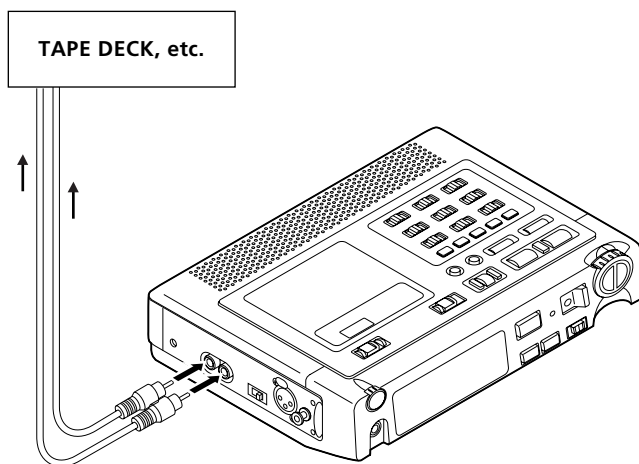

## Connecting Digital Components

The following illustrations show you how to connect digital audio components for recording or playback.

### To record from digital audio components

Connect the source component's digital output jack to this unit's coaxial DIGITAL IN (RCA) jack.

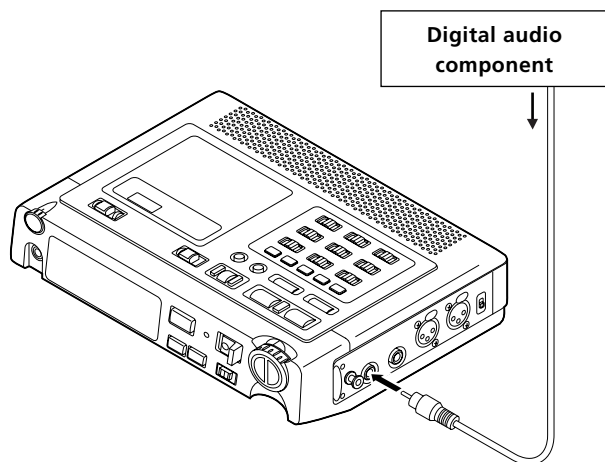

### To output digital audio signals to another audio component

Connect the source component's digital input jacks to this unit's DIGITAL OUT (XLR) jack.

The DIGITAL OUT ON/OFF switch must be set to ON to output digital audio signals (set to OFF when not in use to save battery power).

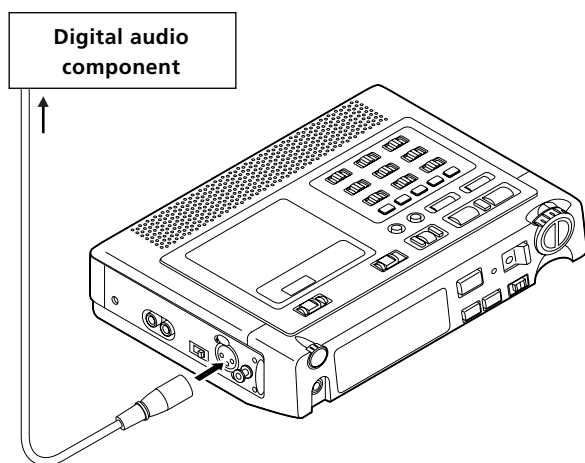

## Other Connections

### Remote control

An optional wired (RC-5) remote control can also be connected.

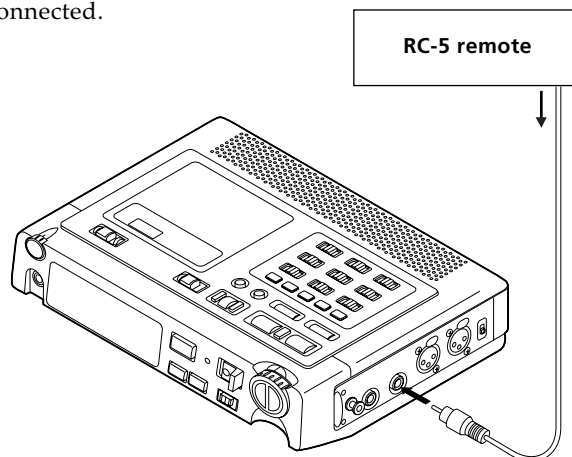

### Available Functions

The remote allows control of the following operations: PLAY, REC, PAUSE, REC-PAUSE, STOP, SKIP (Next, Previous), and SEARCH (Forward, Reverse).

### RC-5 Command Table

Command	RC-5 Code
Stop	2354
Play	2353
Pause	2348
FF	2352
FR	2350
Next	2332
Prev	2333
Repeat	2329
Rec-pause	2340
Record	2355

### Headphones

Connect headphones to the PHONES output to monitor the sound during recording and playback.

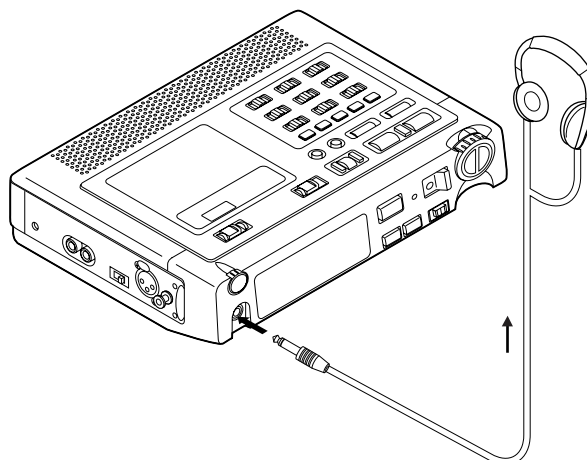

Use the HP/SPK VOLUME knob to control the volume of the headphones. The sound from the internal speaker is muted automatically when headphones are connected.



## Recording with the Built-in Microphone

Before recording with the built-in mono microphone, make sure the following switches are set correctly.

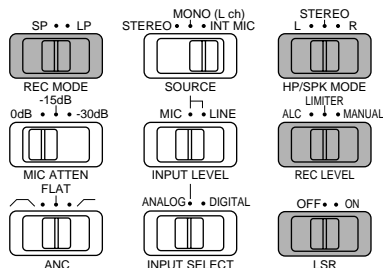

### INPUT SELECT

Set the INPUT SELECT switch to ANALOG, while unit is stopped. "Analog in" appears in the display.

### INPUT LEVEL

Set the INPUT LEVEL switch to MIC.

### SOURCE

Set the SOURCE switch to INT MIC.

Recordings made via the built-in microphone are always mono.

## Recording with External Microphones

Before recording with microphone(s) connected to the MIC/LINE IN jack(s), make sure the following switches are set correctly.

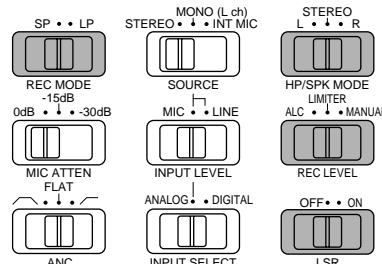

### INPUT SELECT

Set the INPUT SELECT switch to ANALOG. "Analog in" appears in the display.

### INPUT LEVEL

Set the INPUT LEVEL switch to MIC.



### SOURCE

Set the SOURCE switch to specify the kind of source you are recording and the corresponding input jacks.

- STEREO: To record in stereo via the MIC/LINE IN (L) and (R) jacks.
- MONO (Lch): To record a mono source via the MIC/LINE IN (L) jack.

### ANC

Set the ANC (Ambient Noise Control) switch to filter out unwanted frequencies when recording.

-  (band-pass): Cuts low frequency (125 Hz and lower) and high frequency (3 kHz and higher) signals.
- FLAT: Normal frequency characteristics.
-  (high-pass): Cuts low frequency (125 Hz and lower) signals.

### Types of sound cut off by ANC

Wind, rumbling, etc.

### MIC ATTENUATION

Set the MIC ATTEN switch according to the level of the signal you are recording. This allows you to compensate for high level signals and/or noisy environments that can not be compensated for using the REC LEVEL adjustments. This setting will effect the recording level. Be sure to set this switch before adjusting the recording level.

- 0 dB : No attenuation
- -15 dB : 15 dB attenuation
- -30 dB : 30 dB attenuation

## Recording Line Sources

Before recording analog signals via the MIC/LINE IN jack(s), make sure the following switches are set correctly.

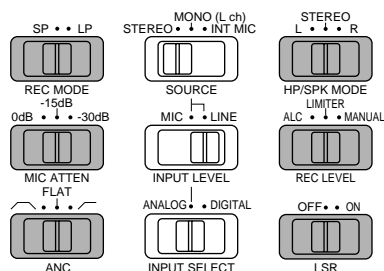

### INPUT SELECT

Set the INPUT SELECT switch to ANALOG. “Analog in” appears in the display.

### INPUT LEVEL

Set the INPUT LEVEL switch to LINE.

### SOURCE

Set the SOURCE switch to specify the kind of source you are recording and the corresponding input jacks.

- STEREO: To record a stereo source via the MIC/LINE IN (L) and (R) jacks.
- MONO (Lch): To record a mono source via the MIC/LINE IN (L) jack.

## Recording Digital Sources

Before recording digital signals via the DIGITAL IN jack, make sure the following switches are set correctly.

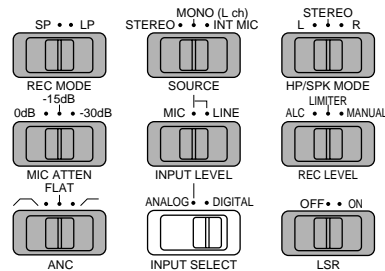

### INPUT SELECT

Set the INPUT SELECT switch to DIGITAL, during the unit is stopped. “Digital in” appears in the display.

### Note

The record level is set automatically during digital recording.

## Recording Operation

This unit can both record LINE or MIC level analog sound as well as a wide variety of digital sound sources (32, 44.1 and 48 kHz).

### Preparation

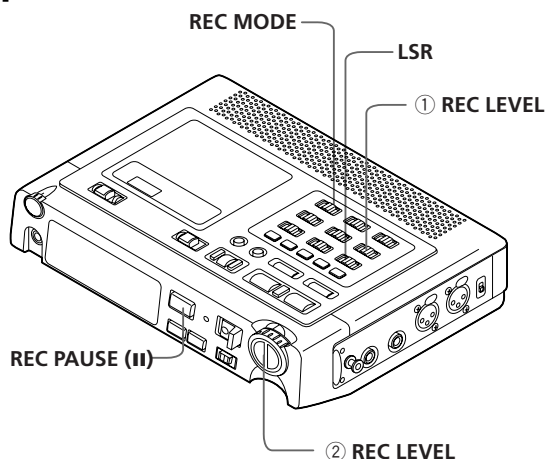

### General

Make sure the date and time are set correctly. (See "Setting the Date and Time" on page 8 for details.)

### REC MODE

Choose the recording mode you desire based on the length and type of recording you wish to make.

- SP (Standard Play mode). For up to 74 minutes of two channel stereo or dual level mono recording (when using a 74 minute MD).

#### When SOURCE is set to STEREO

The L (left) and R (right) channels are recorded in stereo.

#### When SOURCE is set to MONO (Lch)

The L (left) channel is recorded in dual level mono (with L (left) channel at normal sound level and R (right) channel at -15 dB) in MIC INPUT LEVEL mode.

#### When SOURCE is set to INT MIC

The source is recorded in dual level mono (with L (left) channel at normal sound level and R (right) channel at -15 dB).

- LP (Long Play mode). For up to 148 minutes of mono recording (when using a 74 minute MD).

#### When SOURCE is set to STEREO

The L (left) and R (right) channels are mixed together and recorded in mono.

#### When SOURCE is set to MONO (Lch)

Only the L (left) channel is recorded in mono.

#### When SOURCE is set to INT MIC

The source is recorded in mono.

### Note

- Set the REC MODE, INPUT and SOURCE switch in stop mode. Even if these switches are set during recording or rec-pause, the settings may not function.
- When the source is recorded in dual level mono, -15dB lower level is heard from R channel.

### REC LEVEL

Before recording an analog source, perform the following steps to obtain the appropriate recording level. To have the PMD650 set the recording level automatically, simply set the REC LEVEL switch to ALC.

- ① Set the REC LEVEL switch.

ALC (Automatic Level Control): Automated recording level adjustment based on the level of the input signal (REC LEVEL knob does not effect the recording). Time constant is long to prevent sudden fluctuations in the recording level.

LIMITER: Although the recording level must be adjusted manually using the REC LEVEL knob on the front panel, signals over 0 dB trigger an automatic reduction of the recording level. Time constant is short to provide quick restoration of the manually set recording level.

MANUAL: Recording level must be adjusted manually using the REC LEVEL knob on the front panel.

- ② Adjust the REC LEVEL knobs (If you set the REC LEVEL switch to LIMITER or MANUAL.)

First, press REC PAUSE (II) to activate rec-pause mode.

Then watch the audio level meter(s) and monitor the sound source you want to record. Use the REC LEVEL knob(s) to adjust the audio level meter(s) so that the 0 dB indicator(s) just barely flicker at the highest peak from the input signal. The OVER indicator should not light (this would result in clipping).

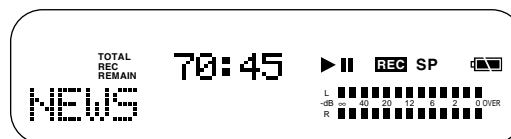

### When recording in stereo

In most cases, adjust the left and right channels so the left and right indicators are nearly equal.

### LSR (for analog sources only)

The LSR (Level Sync Recording) function can start recording automatically (from rec-pause mode) when source signal exceeds a certain level.

(See "Adjusting the System Presets" on page 7 to set the LSR Level.)

- ON (LSR indicator on): When the unit is set to rec-pause mode, recording starts automatically when the source signal exceeds the LSR level.
- OFF (LSR indicator off): LSR function is off.

### Note

Set the LSR switch in stop mode. The function does not switch when the LSR switch is set during recording or playing back. In this case, the function switches in stop mode.

## Operation

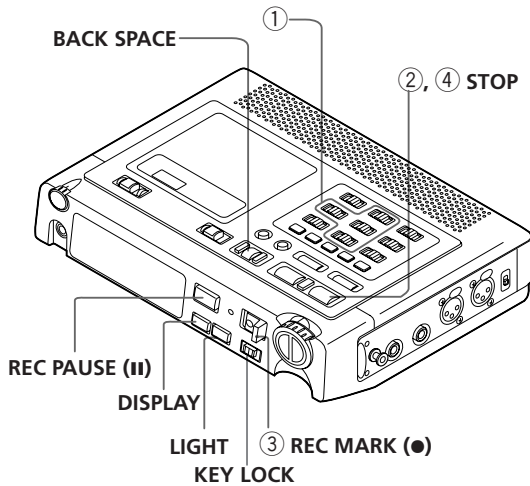

- ① Make sure the INPUT SELECT, INPUT LEVEL, SOURCE, MIC ATTEN, and ANC switches are set appropriately.  
For the built-in microphone : See page 12.  
For external microphones : See page 12.  
For analog sources : See page 13.  
For digital sources : See page 13.
- ② Decide where on the MD you want to record from.  
Press STOP (■).  
**To record from the end of a previous recording (with PRE REC)**  
Press REC PAUSE (II) to activate the rec-pause mode and route the source signal through the memory cache, then proceed to step ③. (A track number is written when you start recording.)  
**To start recording immediately from the end of a previous recording (without PRE REC)**  
Slide REC/MARK (●) to the right without setting the unit to rec-pause mode. The unit immediately starts recording from the end of the previously recorded material. (A new track number is written automatically.)
- ③ Shift REC/MARK (●) to start recording.  
**Notes**  
To take full advantage of the PR\_REC function, be sure to wait a few seconds between steps ② and ③.
- ④ When you've finished recording, press STOP (■).  
The UTOC is updated automatically.

### To pause during recording

Press REC PAUSE (II).

Slide REC/MARK (●) to the right to resume recording (the track number changes).

### To mark a track during recording

Slide REC/MARK (●) to the right.

The current location is marked and the track number increases by one for the subsequent material. Marks must be set at least 1 second apart.

### To switch the information shown in the display

Press DISPLAY repeatedly.

(See "Viewing the date and time" on page 9 for details.)

### To prevent misoperation during recording

Slide KEY LOCK to the right (LOCK) to activate the key lock function. All buttons (except LIGHT) become inoperative.

To release, slide KEY LOCK back to the left (OFF).

- Key lock can also be used during stop or play mode (etc.).

### To stop recording

Press STOP (■).

#### Notes

- No sound is output from the internal speaker during recording or the rec-pause mode.
- The unit stops recording automatically when it reaches the end of the disc.
- When operating from battery power, the power management function will automatically turn the power off after a certain amount of time if the unit is left in rec-pause mode (unless the LSR function is ON).
- When recording from a CD or MD with INPUT SELECT set to DIGITAL, the track numbers are recorded automatically.
- If a standard digital signal is not input to the DIGITAL IN jack after REC/MARK (●) or REC PAUSE (II) has been pressed, "Din Unlock" appears in the display and the unit switches to the stop mode.
- The REC indicator lights differently in the following circumstances:
  - During recording : lights steadily
  - During rec-pause : blinks
  - When the battery is low : blinks quickly (see "Battery replacement" on page 7)

#### BACKSPACE

To cancel the recording, press BACKSPACE while recording.

The recording is discarded and the unit enters rec-pause mode again at the point where recording began.

## Basic Operation

Playback can be monitored through the internal speaker or a pair of headphones. Use the HP/SPK VOLUME knob to adjust the level of the internal speaker or headphones. The audio signal is also output from the LINE OUT jacks and DIGITAL OUT jack (if DIGITAL OUT is ON). The signal level of these jacks is not effected by the HP/SPK VOLUME knob.

### Preparation

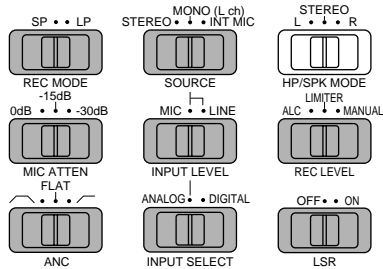

### HP/SPK MODE

Select L (left channel), STEREO (left and right channels in stereo), or R (right channel) according to the channels you want to monitor through the internal speaker or headphones.

#### Notes

- When headphones are connected, no sound comes from the internal speaker.
- When using headphones and playing back a dual level mono recording with HP/SPK MODE set to STEREO, the sound from the right channel will be -15 dB lower than the sound from the left channel.
- When using headphones and playing back a normal mono recording with HP/SPK MODE set to STEREO, the same sound is output from both channels.
- To cut output from the internal speaker (when headphones are not connected) set the HP/SPK VOLUME knob to "0".

## Operation

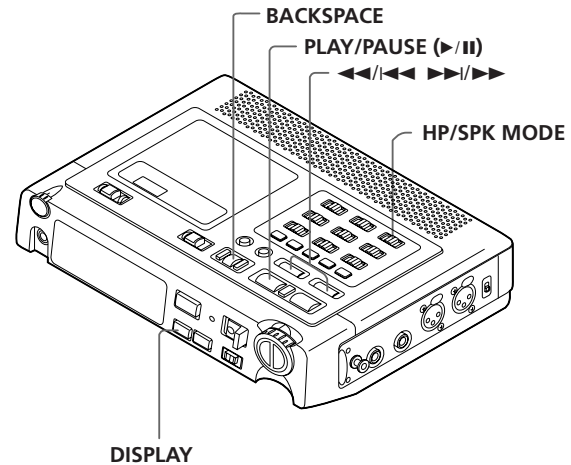

### To start playback

Press PLAY/PAUSE (▶/⏸) during stop mode.

### To pause during playback

Press PLAY/PAUSE (▶/⏸).

Press again to resume playback.

When operating from battery power, the power management function automatically releases the pause and turns the power off after 5 minutes.

### To switch the information shown in the display

Press DISPLAY repeatedly.

(See "Viewing the date and time" on page 9 for details.)

### To stop playback

Press STOP (■).

Playback stops automatically at the end of the last track.

#### Note

When operating from battery power, the power management function will automatically turn the power off after a certain amount of time if the unit is left in pause mode.

### BACKSPACE

To go back a few seconds, press BACKSPACE.

Play skips back 5 seconds, then continues.

Press repeatedly to skip backward in additional 5 second increments.

#### Notes

- BACKSPACE only operates within the current track.
- When BACKSPACE is pressed at a point less than 5 seconds from the beginning of the track, playback starts from the beginning of the track.

### Quick playback

During stop or play-pause mode, press ►►/►► while holding down the PLAY/PAUSE (▶/⏸) button to start quick playback (playback at about twice normal speed). Press PLAY/PAUSE (▶/⏸) again to resume playback at normal speed. (Please note that BACKSPACE does not function during quick playback.) The repeat play is not possible during quick playback.

## Searching

### To search forward during play or pause

Press and hold FF/NEXT (▶▶/▶▶).

When the unit reaches the end of the last track while searching in play mode, the unit enters stop mode. When the end of the last track is reached while searching in pause mode, the unit remains in pause mode.

### To search in reverse during play or pause

Press and hold FR/PREV (◀◀/◀◀).

When the unit reaches the beginning of the first track, during play or pause mode, the unit enters normal play or pause mode.

#### Notes

- The sound can be heard (12 dB lower) when searching in play mode to help you locate the desired position within the track. No sound is heard when searching in pause mode, but the search is conducted at a higher speed.
- Search may not function correctly when there are several consecutive tracks consisting of only a few seconds apiece.

## Skipping to Other Tracks

### To skip to the next track

Press FF/NEXT (▶▶/▶▶).

Additional presses skip to the beginning of later tracks. When the ▶▶/▶▶ is pressed in the last track, the unit skips to the first track.

### To skip to a previous track

Press FR/PREV (◀◀/◀◀).

Press once to skip to the beginning of the current track. Each Additional presses skip to the beginning of previous tracks. When the ◀◀/◀◀ is pressed in the first track, the unit skips to the last track.

## Repeat Play

You can have the unit play a single track, the full disc, or just part of a track repeatedly.

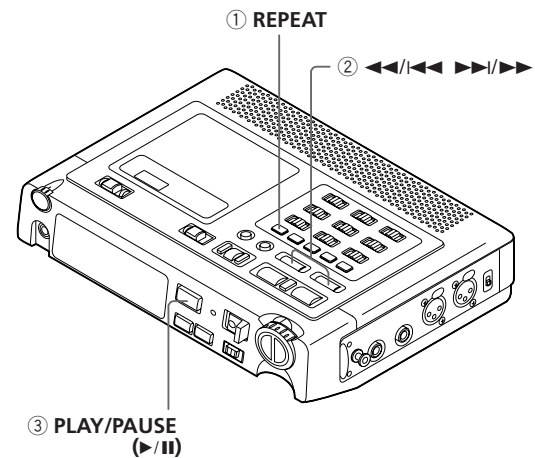

## Repeating a track

- ① Press REPEAT so that REPEAT 1 appears in the display.
- ② Use FF/NEXT (▶▶/▶▶) or FR/PREV (◀◀/◀◀) to select the track you want to repeat.
- ③ Press PLAY/PAUSE (▶/||) to start repeat playback.

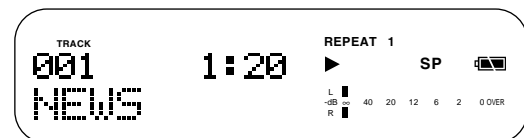

### To cancel

Press REPEAT repeatedly until REPEAT and REPEAT 1 disappear from the display.

## Repeating the entire disc

Press REPEAT repeatedly so that REPEAT appears in the display.

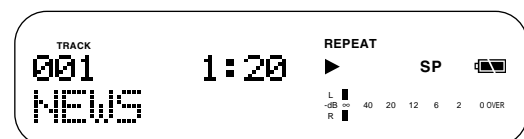

### To cancel

Press REPEAT repeatedly until REPEAT and REPEAT 1 disappears from the display.

## Repeating part of a track (A-B)

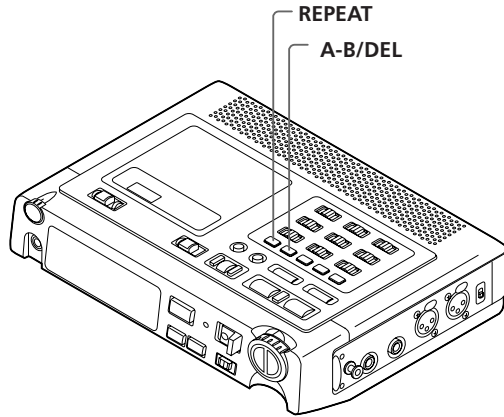

### To cancel

- Press REPEAT during the A-B repeat playback.  
“REPEAT A-B” disappears.
- Press STOP (■).

- ① Start playback.
- ② Press A-B/DEL at the beginning of the part you want to repeat.  
“REPEAT” lights up and “A-” blinks.



- ③ Press A-B/DEL again at the end of the part you want to repeat to start the A-B repeat.  
“REPEAT A-B” lights up.



- ④ Press A-B/DEL again to change the end point (point B) to the start point.
- ⑤ Press A-B/DEL to set the new end point (new point B) and start A-B repeat.

### Notes

- A-B repeat across more than one track is not possible. (If the next track is entered after having set point A in a track, the A-B repeat is canceled automatically.)
- Pressing FR/PREV (◀◀/◀) or FF/NEXT (▶▶/▶) cancels A-B repeat.
- A-B repeat is also canceled when the divide rehearsal operation is performed.
- When an attempt is made to set new point B (by pressing A-B/DEL) before new point A, the new point B setting attempt is ignored.

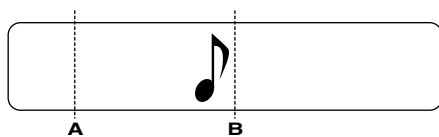

Pressing A-B/DEL during A-B repeat changes point B to point A. (Step ④)

Point B cannot be set in this section.

## Dividing a Track

This function will divide a track into two different tracks. After dividing the track, the total number of tracks increases by one and the tracks following the divided track are renumbered automatically.

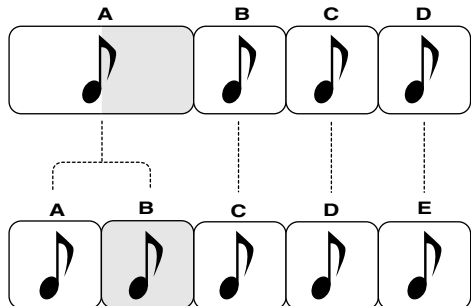

- ① Press PLAY/PAUSE (▶/⏸) to pause playback at the point where you want to divide the track.
- ② Press EDIT < or > repeatedly until "Divide?" is displayed, then press ENTER.  
"Rehearsal" and "Pos. Ok?" appear alternately in the display and the unit plays back the divide point (selected in step ①).
- ③ If necessary, use ◀◀/|◀◀ and ▶▶/|▶▶ to adjust the divide point.  
The divide point can be adjusted from -127 to +128 steps in either direction (about 0.06 second interval).
- ④ Press ENTER to divide the track.  
"Complete!" appears in the display and the unit returns to the normal play mode.

### To cancel before dividing the track

Press EDIT < or > or STOP (■) any time before step ④.

### To divide quickly

- ① Start playback.
- ② Slide REC/MARK (●) to the right at a point in which you want to divide the track.  
The track number and time are changed automatically.

#### Notes

- You can also combine the tracks later using the combine function.
- The disc can only be ejected after completion of writing UTOC.
- Even during playback, the dividing operation (rehearsal function) can be carried out.

## Combining Tracks

This function will combine two adjacent tracks into one track. After combining the tracks, the total number of tracks decreases by one and the tracks following the combined tracks are renumbered automatically.

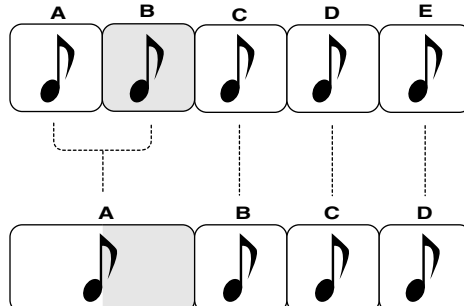

- ① Press STOP (■) to stop playback.
- ② Press EDIT < or > repeatedly until "Combine?" is displayed, then press ENTER.  
"Tno = 001" is displayed.
- ③ Press ◀◀/|◀◀ or ▶▶/|▶▶ to select the first track of the two you want to combine.  
"Tno = xxx" is displayed.
- ④ Press ENTER.  
"Rehearsal" and "Track Ok?" appear alternately in the display and the unit plays back the last 4 seconds of the first track and the first 4 seconds of the next track.
- ⑤ Press ENTER to combine the tracks.  
"Complete!" appears in the display and the unit returns to the normal play mode at the beginning of the first track.

### To cancel before combining the track

Press EDIT < or > or STOP (■).

If the button is pressed in step ② or ③, the unit enters the stop mode. If the button is pressed in step ④, the unit plays back normally.

### To combine two tracks quickly

WARNING: The following operation does not request confirmation before combining the tracks.

- ① Press PLAY/PAUSE (▶/⏸) to pause playback or stop.
- ② Press ◀◀/|◀◀ or ▶▶/|▶▶ to select the second track of the two you want to combine.
- ③ Slide REC/MARK (●) to the right.  
The tracks are combined, the track number is erased, and playback starts from the beginning of the first track.

#### Notes

- You can also divide the tracks later using the divide function.
- When the tracks are combined, the title information of the second track is erased.
- Certain tracks may not be combined. If they are different in speed mode (SP/LP), SCMS on/off, emphasis on/off, or tracks are less than 2 seconds.



## Moving a Track

This function will change the position of any track. First you select the track you want to move, then you specify the track number you want to move it to. After moving the track, the tracks are renumbered automatically. You can perform this operation repeatedly to completely reorder the disc.

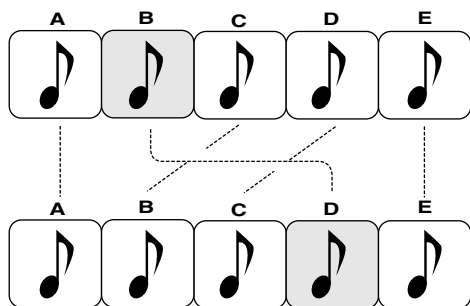

- ① Press STOP (■) to stop playback.
- ② Press EDIT < or > repeatedly until "Move?" is displayed, then press ENTER.  
"From = 001" is displayed.
- ③ Press ◀◀/|◀◀ or ▶▶/|▶▶ to select the track you want to move.  
"From = xxx" is displayed.
- ④ Press ENTER.  
"To = 001" is displayed.
- ⑤ Press ◀◀/|◀◀ or ▶▶/|▶▶ to select the track you want to move to.  
"To = xxx" is displayed.
- ⑥ Press ENTER.  
"Complete!" appears in the display, UTOC is updated, then the unit enters stop mode.

### To cancel before moving the track

Press EDIT < or > or STOP (■) any time before step ⑥.

## Erasing a Disc or Track

Use the following operations to erase an entire disc or an individual track.

**Please note, these operations cannot be undone.**

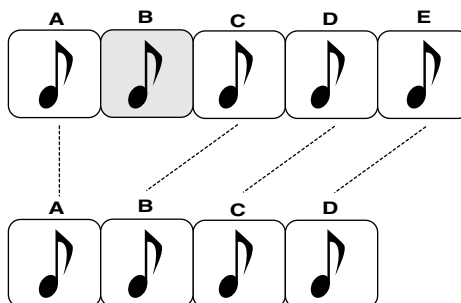

### Erasing an entire disc

- ① Press STOP (■) to stop playback.
- ② Press EDIT < or > repeatedly until "EraseAll?" is displayed, then press ENTER.  
"EraseAll?" blinks.
- ③ Press ENTER to erase the entire disc.  
"Complete!" appears in the display.

### To cancel before erasing the disc

Press EDIT < or > or STOP (■) any time before step ③.

### Erasing a track

- ① Press STOP (■) to stop playback.
- ② Press EDIT < or > repeatedly until "Erase?" is displayed, then press ENTER.  
"Tno = 001" is displayed.
- ③ Press ◀◀/|◀◀ or ▶▶/|▶▶ to select the track you want to erase.  
"Tno = xxx" is displayed.
- ④ Press ENTER to erase the track.  
"Complete!" appears in the display, UTOC is updated, then the unit enters stop mode.

### To cancel before erasing the track

Press EDIT < or > or STOP (■) any time before step ④.

# Titling a Disc or Track

This function will allow you to input titles for the disc or an individual track. Titles may consist of uppercase and lowercase letters, numbers, and symbols for a maximum of up to 80 characters for each title (totally 1700 characters for disc titles and track titles).

**Note**

The following operations can also be used to correct previously input titles on recordable MDs.

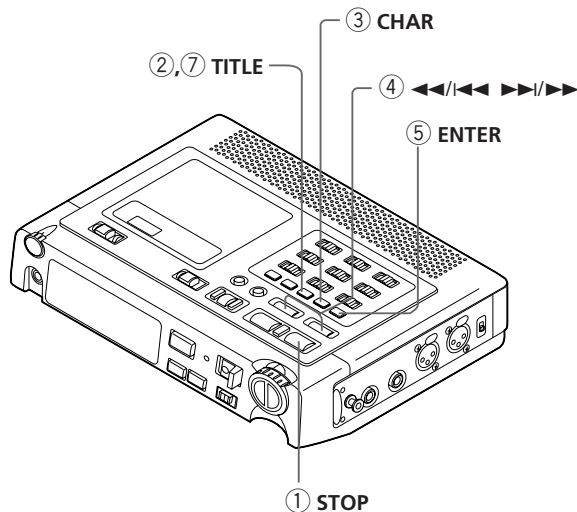

- ① To title a disc:  
Press STOP (■) to stop playback.  
To title a track:  
**During playback, pause, or stop mode**  
Press ◀◀/▶▶ or ▶▶/▶▶ to select the track you want to title, or go directly to step ② to title the current track.  
The titling must be completed before the track ends, or it will be discarded.  
**During recording**  
Go directly to step ② to title the current track.  
Recording continues normally while you are entering the title for the selected track.
- ② Press TITLE to activate the title mode.  
If the track has no title, a blinking "A" appears.  
If the track was previously titled, the first character blinks.
- ③ Press CHAR repeatedly to select uppercase letters (A), lowercase letters (a), numbers (0), or symbols (!).
- ④ Press ◀◀/▶▶ or ▶▶/▶▶ to select the desired character.  
Keep pressing FR/PREV or FF/NEXT to change the character continuously.

- ⑤ Press ENTER to enter the selected character.  
The blinking moves into the position for the next character.
- ⑥ Repeat steps ③ through ⑤ to complete your title.  
**To correct a character (e.g., ABCD → ABTD)**  
1 Press EDIT < or > repeatedly to select the character you want to correct.  
2 Use CHAR, ◀◀/▶▶, and ▶▶/▶▶ to select a new character, then press ENTER.  
**To insert a character (e.g., ABCD → ABTCD)**  
1 Press EDIT < or > repeatedly to select the character in the position at which you want to insert the new character.  
2 Use CHAR, ◀◀/▶▶ and ▶▶/▶▶ to select a new character, then press ENTER.  
**To delete a character (e.g., ABCD → ABD)**  
1 Press EDIT < or > repeatedly to select the character you want to delete.  
2 Press A-B/DEL.
- ⑦ Press TITLE to exit the title mode.  
If a title consists of more than 10 characters, it will scroll across the display.

**To cancel before finishing the title**

Press STOP (■) any time before step ⑦.

**Notes**

- When the TITLE is pressed to complete the title (step ⑦) during stop mode, "Complete!" is displayed and the UTOC is updated.
- When the TITLE is pressed to complete the title (step ⑦) during playback, pause, or recording, press STOP (■) to update the UTOC before ejecting the disc.

Character Table																											
A	B	C	D	E	F	G	H	I	J	K	L	M	N	O	P	Q	R	S	T	U	V	W	X	Y	Z	(space)	
a	b	c	d	e	f	g	h	i	j	k	l	m	n	o	p	q	r	s	t	u	v	w	x	y	z	(space)	
0	1	2	3	4	5	6	7	8	9	(space)																	
!	"	#	\$	%	&	'	(	)	*	+	,	-	.	/	:	;	<	=	>	?	@	[	¥	^	_	`	(space)

---

## **System Limitations**

---

The recording system in this MD recorder is radically different from those used in cassette and DAT decks and is characterized by the limitations described below. Note, however, that these limitations are inherent to the MD recording system and are not a result of mechanical trouble.

### **“Disc Full” is displayed before reaching the maximum recording time (60 or 74 minutes)**

Once 255 tracks have been recorded on one MD, “Disc Full” is displayed regardless of the total recorded time. More than 255 tracks cannot be recorded on one MD. To continue recording, erase all tracks, or use another recordable MD.

### **The remaining recording time does not increase even after erasing numerous short tracks**

Tracks under 4 seconds in length are not counted. Therefore erasing them may not lead to increase the recording time.

### **“Reading” is displayed continuously**

The “Reading” display lasts longer than normal when a brand new (blank) disc is inserted.

### **The total recorded time and the remaining time on the MD do not total to the maximum recording time**

Recording is done in minimum units of 2 seconds each, no matter how short the material. The contents recorded may thus be shorter than the maximum recording capacity. Disc space may also be further reduced by scratches.

### **Tracks created through editing may exhibit sound dropout during search operations.**

### **Track numbers are not recorded correctly**

Depending on the recorded content of the CD, short tracks may be created when making a digital recording from CD.

### **EVENT REMAIN**

PMD650 has limitation in number of tracks and divide (255 Maximum). If remained number is decreased to less than 51, “EV\_REM=XXX” (XXX: 000 - 050) appears on display for about 2 seconds after UTOC reading or writing is completed.

If “EV\_REM=000” or Remain time is “0:00”, Recording and Divide are not possible.

We recommend you to use new disks if EV\_REM=XXX appears on display.

## SCMS Copy Protection

As a digital audio component, this MD recorder conforms with the Serial Copy Management System (SCMS) standards. However, this function can be turned off using the "SCMS" system preset. The Serial Copy Management System restricts copies made by recording digital signals to first-generation copies only. Therefore, an MD recorded through a digital input cannot be used as a source for making another digital recording.

However, subsequent recordings can be made from the first-generation copy by using the analog input/output jacks.

There are three general rules that apply to this unit.

### Rule 1

You can record from digital program sources (CDs, DATs or pre-mastered MDs) onto a DAT tape or recordable MD via the digital input jack on a DAT or MD recorder. You cannot, however, record from this recorded DAT tape or MD to another DAT tape or recordable MD via a digital input jack.

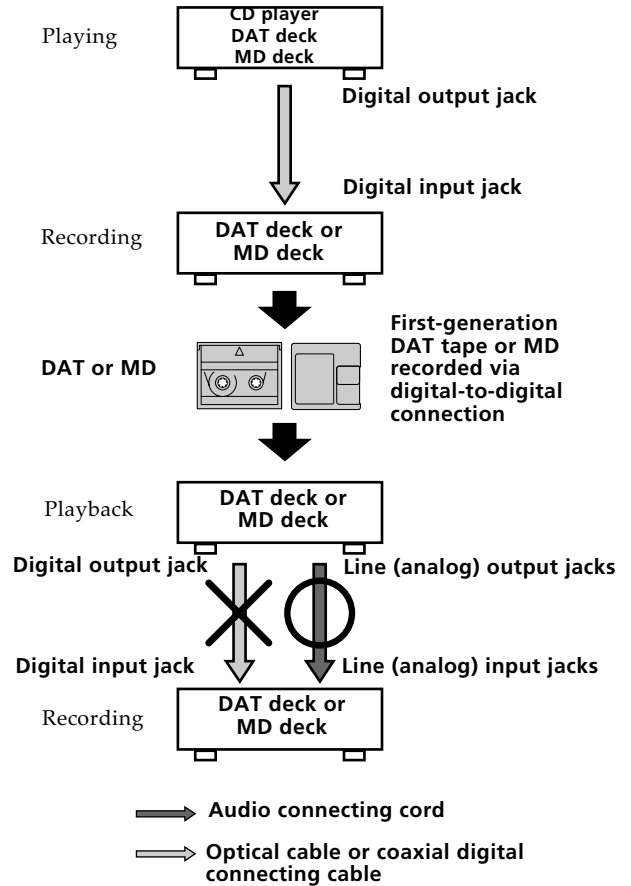

# ADDITIONAL INFORMATION

## Rule 2

You can record a digital signal input from a digital satellite broadcast onto a DAT tape or recordable MD via the digital input jack on the DAT or MD recorder. (This unit is equipped with a sampling rate converter that allows you to make digital recordings from 32 kHz or 48 kHz digital program sources).

If the broadcast does not contain a copyright protection code, you can then record the contents of this recorded DAT tape or MD (first-generation) onto another DAT tape or recordable MD via a digital input jack on the DAT or MD recorder to create a second generation digital copy (these copies may also be copied digitally). Note, however, that if the broadcast contains a copy protection code, second-generation digital copying will not be possible.

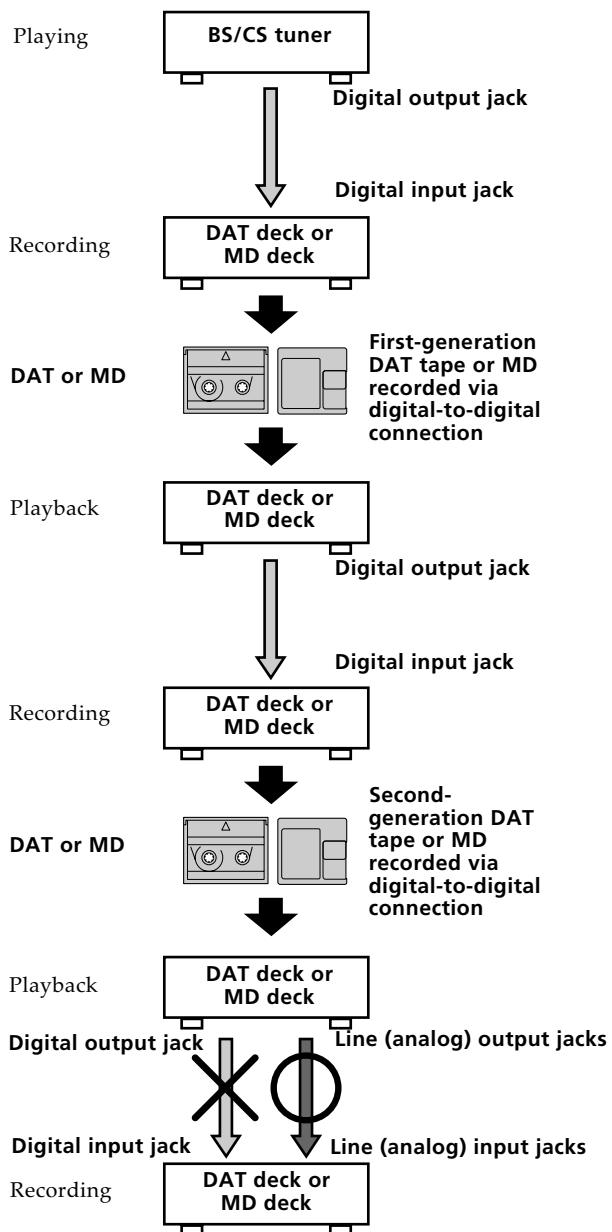

— Audio connecting cord  
— Optical cable or coaxial digital connecting cable

## Rule 3

You can record a DAT tape or MD recorded via the DAT or MD recorder's analog input jack onto another DAT tape or recordable MD via the DAT or MD recorder's digital output jack. You cannot, however, make a second-generation DAT tape or MD copy via the DAT or MD recorder's digital output jack.

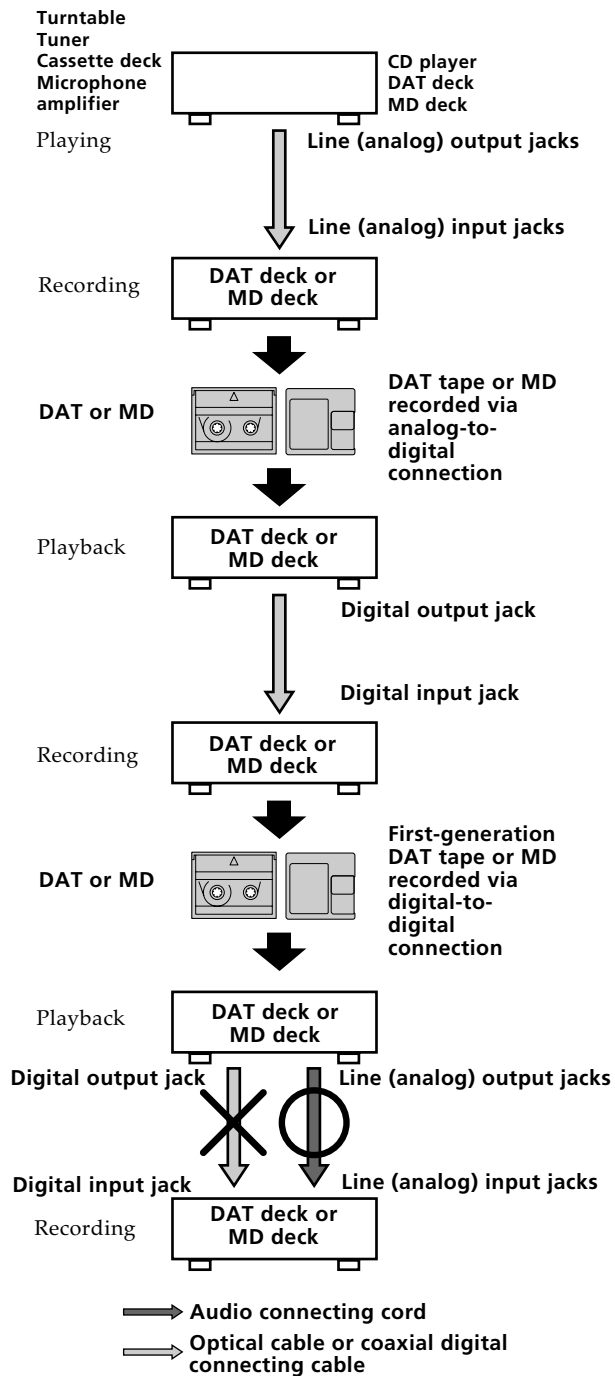

## Troubleshooting

If your unit fails to operate normally, check the symptoms and solutions described below which you can take to correct the problem. If it cannot be corrected, or the symptom is not listed, contact your authorized MARANTZ dealer or service center for help.

### The unit does not respond to operations.

- Make sure you have installed fresh or fully charged batteries, or that the AC power adaptor is connected correctly.
- Make sure the batteries are loaded with correct polarity (+ and -).
- Make sure the power is turned on.
- Make sure KEY LOCK is not set to the right (LOCK) position.

### Playback is not possible.

- Condensation has formed on the MD. Wait a few minutes for it to evaporate.
- Make sure you have not loaded a blank disc.

### Recording is not possible.

- Make sure you have inserted a recordable MD.
- Make sure the record protection tab is closed.
- Make sure the sound source connected correctly.
- When recording an analog source, make sure the recording level is adjusted correctly.
- Make sure there is enough time available for recording on the disc.
- If the AC adaptor is unplugged, or there is a power outage during recording, all material recorded up to that point will be lost. If the recording was not successful, resume recording again from the beginning.

### Excessive noise.

- Make sure the unit is not near a TV (etc.).

### Note

This unit incorporates a high quality microprocessor. If, however, it happens to malfunction because of static electricity (etc.), unplug the AC adaptor (or remove the batteries), wait 30 seconds, reconnect the AC adaptor (or reload the batteries), then press the reset button on the rear panel. Pressing the reset button will clear the contents of the memory (UTOC).

### About recording

- Do not shake the unit or subject it to any sudden shock or bump during recording. This may cause the recording to skip or to stop completely. Also be careful not to shock or bump the unit after recording, when "Writing" appears in the display and the unit is writing the recorded information to the disc.
- Sound from the internal (or external) microphone is conveyed via analog circuitry before being converted to a digital signal and recorded. Therefore some analog noise may be present in the recorded signal. Also, when recording with the internal microphone in an extremely quiet environment, there is a possibility of recording the sound of this unit operating. This is not a malfunction.

### About condensation

If this unit is brought directly from a cold location to a warm location, or is placed in a very damp room, moisture may form on the lenses inside the deck. This is called condensation. In this state, not only is the normal operation impossible, operation may cause damage to the MD or the unit itself. Be sure to eject the MD when not using this unit.

If condensation occurs, leave the unit turned on for about an hour until the moisture evaporates (do not perform any operations during this time). After an hour, turn the unit off, then turn it back on and operate as normal. If the unit cannot be operated normally no matter how long you wait, please contact a service center.

### To clean the cabinet

Use a soft cloth slightly moistened with mild detergent solution.

### Care of MDs

- Do not expose the MD to direct sunlight or heat sources such as hot air ducts, nor leave it in a car parked in direct sunlight as there can be a considerable rise in temperature inside the car.
- Periodically remove dust and debris from the cartridge surface by wiping it with a dry cloth.
- As the MD itself is housed in a cartridge, you can handle it normally without being concerned about dirt or fingerprints. However, malfunctioning may result if the cartridge itself is dirty or warped.

### Do not open the shutter on the MD cartridge

Trying to force the shutter open will damage the shutter.

## Display Messages

### Blank Disc

The inserted disc is blank (nothing has been recorded on it).

### No Disc

There is no disc in the MD slot.

### Disc Error

The disc loaded in the disc slot is not an audio MD.

### Play Only

The inserted MD is designed for playback only (you cannot record on this disc).

### Protected

The record protection on the inserted MD is set to "protect".

### Can't Edit

Edit operation is not possible.

### Input ERR

The track number input during the combine operation was incorrect.

### Impossible

The selected operation is not possible.

### Disc Full

Recording is not possible because there is not enough blank space remaining on the disc.

### HIGH DC IN

The DC power voltage is higher than the specified voltage. When this message appears, the unit writes the UTOC and then turns itself off automatically.

### LOW BATT

The battery voltage is lower than the specified voltage. When this message appears, the unit writes the UTOC and then turns itself off automatically.

### KEY LOCK

The KEY LOCK control is set to ON. If you wish to perform an operation, slide the KEY LOCK switch to the left (OFF).

### Reading

The unit is reading the UTOC data.

### Writing

The UTOC data is being written to the disc. Do not move the unit or pull out the AC adaptor. If you do, recorded material may not be saved normally.

## Specifications

### DIGITAL AUDIO SYSTEM

#### System

MiniDisc digital audio system

#### Disc

MiniDisc

#### Recording method

Magnetic field variation overwrite

#### Reading method

Non-contact optical pickup (using semiconductor laser)

#### Laser

Semiconductor laser

#### Laser Diode Properties

Material: GaAIAs

Wavelength: 780 nm

#### Record/playback time

SP mode (stereo): 74 minutes max.

LP mode (mono): 148 minutes max.

#### Revolutions

Approx. 400~900 rpm (CLV)

#### Error Correction

ACIRC (Advanced Cross Interleave Reed-solomon Code)

#### Sampling frequency

44.1 kHz (32 kHz and 48 kHz signals converted to 44.1 kHz for recording)

#### Coding

ATRAC (Adaptive Transform Acoustic Coding)

#### Modulation System

EFM (Eight-to-Fourteen Modulation)

#### Number of channels

2 (stereo) or 1 (mono)

**AUDIO SPECIFICATIONS**

**Frequency Response**

20 Hz ~ 20 kHz

**Signal-to-Noise Ratio (IEC-A weighted)**

85 dB

**Total Harmonic Distortion (at 0 VU)**

0.02%

**Dynamic Range**

85 dB

**Headphone Output Power**

15 mW / 32 ohms

**Speaker Output Power**

200 mW

**Phantom Power**

+48V, 5 mA

**Inputs:**

Reference level: -12 dB (Full scale 0 dB)  
0 dBu = 0.775 Vrms

**(MIC/LINE IN L/R)**

Type: XLR (1: GND, 2: HOT, 3: COLD)

Input sensitivity (MIC): -60 dBu/9 kilohms

Input sensitivity (LINE): -20 dBu/47 kilohms

**(DIGITAL IN)**

Type: coaxial (RCA) jack

Input impedance: 75 ohms

Input level: 0.5 Vp-p

**Outputs:**

**(LINE OUT L/R)**

Type: RCA jack

Output level: 2 Vrms max./2 kilohms

**(DIGITAL OUT)**

Type: XLR

Output impedance: 110 ohms

Output level: 3.3 Vp-p

**GENERAL**

**Power Supply**

DC 13 V

**Power Consumption**

Recording: 5.5 W

Standby: 3.5 W

**Dimensions (W x H x D)**

264 x 54.8 x 185 mm

**Weight (without battery)**

1.3 kg (2 lbs. 14 oz.)

**Accessories**

Battery holder: 1

Carrying Strap: 1

Owner's Manual: 1

AC adaptor: 1

**Optional Accessories**

NiCd Battery Pack (RB1100)

Carrying Case (74CLC650/09B)

Manufactured under license from Dolby Laboratories Licensing Corporation.

Specifications subject to change without notice.